

## New ultrafiltration (UF) membrane made with a new polymer material for long-lasting rejection performance, Neophil<sup>®</sup>

Olivier Lorain<sup>a,\*</sup>, Sébastien Marcellino<sup>a</sup>, André Deratani<sup>b</sup>, Sana Gassara<sup>b</sup>,  
Isabelle Duchemin<sup>IWA<sup>a</sup></sup> and Jean-Michel Espenan<sup>IWA<sup>a</sup></sup>

<sup>a</sup> Polymem, 3 rue de l'Industrie 31320, Castanet-Tolosan, France

<sup>b</sup> Institut Européen des Membranes, IEM, UMR 5635, Université de Montpellier, ENSCM, CNRS, Place Eugène Bataillon, 34095 Montpellier Cedex 5, France

\*Corresponding author. E-mail: o.lorain@polymem.fr

---

### Abstract

This paper focuses on the development of a new membrane, named Neophil<sup>®</sup>, with durable performance using a new amphiphilic nanostructured dibloc-copolymer (BCP) composed of one hydrophilic bloc and one hydrophobic bloc which is anchored deeply and permanently in the polymer matrix (PVDF, Kynar resin Arkema) of the membrane. Compared to conventional membranes, particle rejections (suspended solids, microplastics, bacteria and viruses) have been shown to be maintained through accelerated ageing experiments. In this paper, this new membrane technology is described and its durability is demonstrated and compared with other membranes of the market.

**Key words:** block-copolymers, durable hydrophilicity, hollow fiber, PVDF, ultrafiltration (UF)

---

### INTRODUCTION

Today, materials used for the production of polymeric ultrafiltration membrane are mainly based on sulphonated polymers like PSU and PES or fluorinated polymers like PVDF (Pearce 2011). Surprisingly these materials, which are intrinsically hydrophobic and prone to be fouled by natural or artificial organic matter contained in most waters and wastewaters, have been progressively chosen in the past decades. The main reason was due to their mechanical and chemical resistances which have permit to increase the robustness of ultrafiltration processes at very large scales. Indeed, the operators of very large water treatment plants prefer to use more chemicals and to clean more often their membranes rather than having to shutdown the plant and to pass time to detect and repair membrane breakages.

Moreover, the membrane manufacturers incorporate hydrophilic additives during membrane fabrication which permit to provide a good hydrophilicity to the hydrophobic membrane material. These additives which have low molecular weights like PEG or PVP, are most of the time blended in the early stage of membrane fabrication (during the dope preparation and before phase inversion) in order to incorporate them deeply in the membrane matrix. Consequently, the newly manufactured membranes offer good hydrophilicity levels with good filtration behavior.

However, because only weak bonds are formed between the hydrophobic membrane matrix and these hydrophilic additives, the additives are easily released during membrane operation. Furthermore, these additives have a weak resistant to oxidants like chlorine (one of the main chemical used to clean or to disinfect membrane processes); thus, their polymeric chains are fragmented which facilitates even more their release out of the membrane matrix (Causserand *et al.* 2015; Ravereau *et al.* 2016).

In this paper the fabrication of an innovative PVDF membrane with an amphiphilic bloc copolymer is described and its benefits presented on long term fouling behavior. The use of block copolymers in membrane fabrication for aqueous solutions application has been well summarized by Nunes (2016). In her paper, block copolymers are only used in pore morphology tuning with success but today, these homogenous and well distributed pores are only obtained at small scales and not at an industrial level.

In this paper, the use of block copolymer (BCP) as a hydrophilic additive is studied to minimize fouling, and the final objective is to manufacture hollow fibers with reproducible and scalable processes. Furthermore, because the block copolymers are deeply anchored into the PVDF matrix, hydrophilicity is expected to be maintained for a long time in the matrix. Liu *et al.* (2015) described a similar study for oil/water emulsion separation using block like copolymer bearing hydrophobic polybutylmethacrylate (PBMA) and hydrophilic poly(poly(ethylene glycol) methyl ether methacrylate) (PEGMA). However, this additive is not sufficiently resistant to membrane cleaning agents.

## MATERIAL AND METHODS

The newly developed membrane material Neophil<sup>®</sup> uses amphiphilic, a nanostructured dibloc-copolymers additive consisting of one hydrophilic bloc polyhydroxyethylmethacrylate (pHEMA) and one hydrophobic bloc polymethylmethacrylate (PMMA), Kosar *et al.* (2017). The latter block enables a deep and a permanent anchoring into the PVDF matrix of the membrane and thereby the former affords a durable hydrophilicity. Oikonomou *et al.* (2017) have shown by staining hydrophilic block with RuO<sub>4</sub> the block copolymers (BCP) are located preferably at the surface of the pores, Figure 1.

SEM analysis was made to characterize the membrane morphology, Figure 2. An asymmetric membrane with a UF skin, in the outer surface was obtained. The average size of pores is less than 20 nm, which is unusual with PVDF membrane. BCP improves the pores structure forming which has been already shown by Oikonomou *et al.* (2017).

In order to evaluate the benefits of BCP addition in comparison with PVP; 3 membranes (Table 1) were aged with aggressive chlorine solutions.

M1 membrane was produced on the same equipment as Neophil but without BCP in the dope solution. It has a geometry identical to M2 i.e. an outer diameter (OD) of 0.72 mm. In contrast,

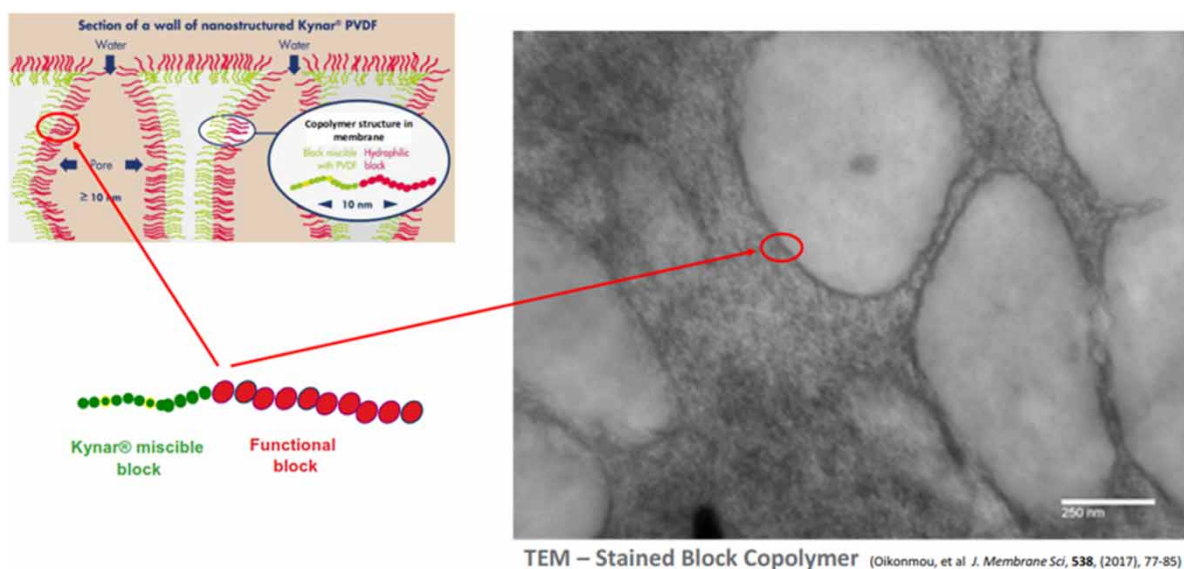

**Figure 1** | Stained block copolymer with RuO<sub>4</sub> in Neophil<sup>®</sup> membrane wall.

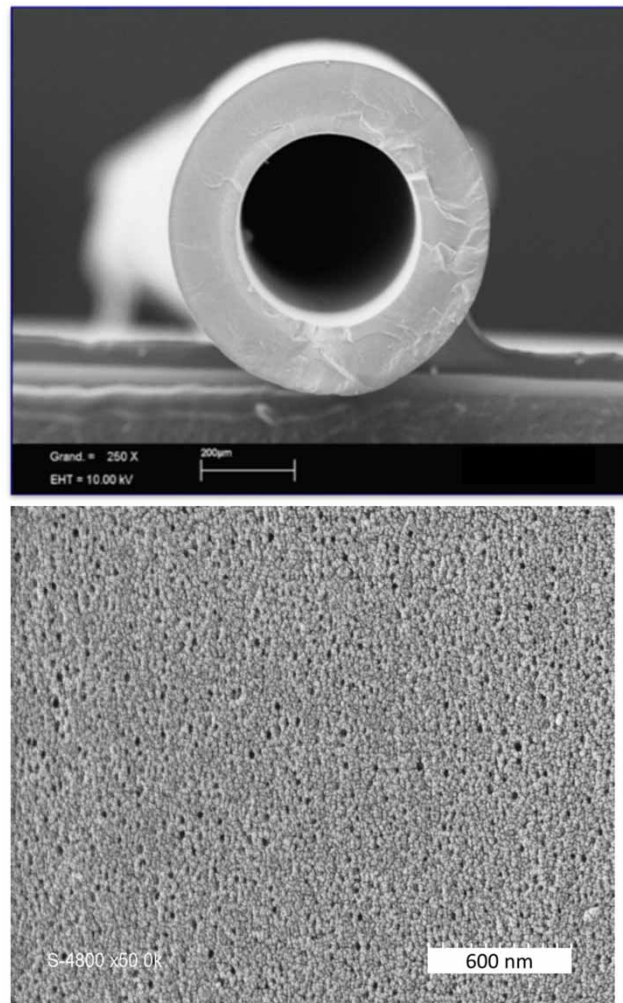

**Figure 2** | Hollow fiber SEM pictures showing outer surface pore sizes distribution of 19 nm.

**Table 1** | Membranes used for ageing test

Membranes	Additives	Polymer
M1	PVP only	PVDF
M2 Neophil <sup>®</sup>	BCP and PVP	PVDF
M3 Commercial	PVP	PVDF

M3 was supplied from another manufacturer of membranes. It was chosen as a reference because it's a market-leading membrane based on PVDF with only PVP as a hydrophilic additive.

Minimodules of each membrane have been manufactured with an identical surface of 0.01 m<sup>2</sup>. The features of the minimodules are detailed in [Table 2](#).

The scheme of the membrane aging bench is described in [Figure 3](#).

The ageing solution is prepared from UF water blended with a bleach solution (NaOCl) at 12.5% to obtain a chlorine concentration of 1,000 ppm. The pH is adjusted to  $6.5 \pm 0.5$  using an acid solution of HCl at 1 M. The vessel of the aging solution is covered with a black plastic film to avoid the chlorine photo-degradation. The aging solution fed the 3 minimodules via 3 peristaltic pumps set at the same filtration fluxes of 10 L/h.m<sup>2</sup>. The aging solution crossed dynamically all the walls of the membranes assuring a homogenous aging of the whole structure and the extraction of the polymer chains ([Figure 4](#)) degraded by chlorine oxidation.

**Table 2** | Minimodules features

Minimodules features	M1	M2	M3
Membrane OD (mm)	0.72	0.72	1.3
Length (mm)	250	250	250
Number of fibers	18	18	10
Outer surface (m <sup>2</sup> )	0.01	0.01	0.01
Module diameter (mm)	16	16	16

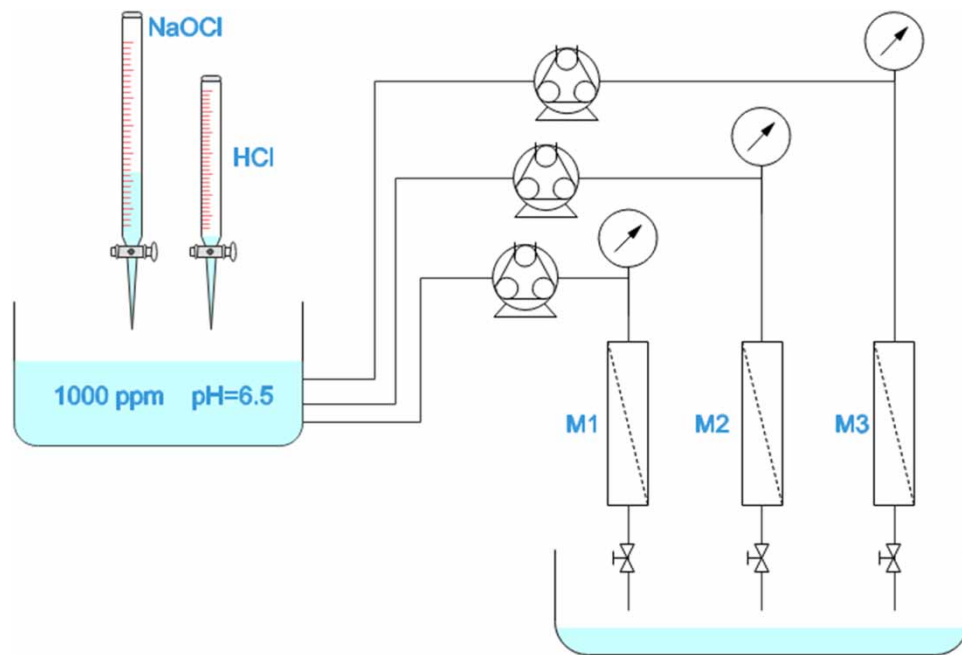
**Figure 3** | Chemical membrane aging bench.

In **Figure 4**, the blue arrows represent the aging solution (chlorine) passing through the membrane wall from the outside to the inside of the membrane during the filtration and the green arrows represent this aging solution with the extracted polymer PVP (chlorine + PVP) going to the permeate side of the membrane.

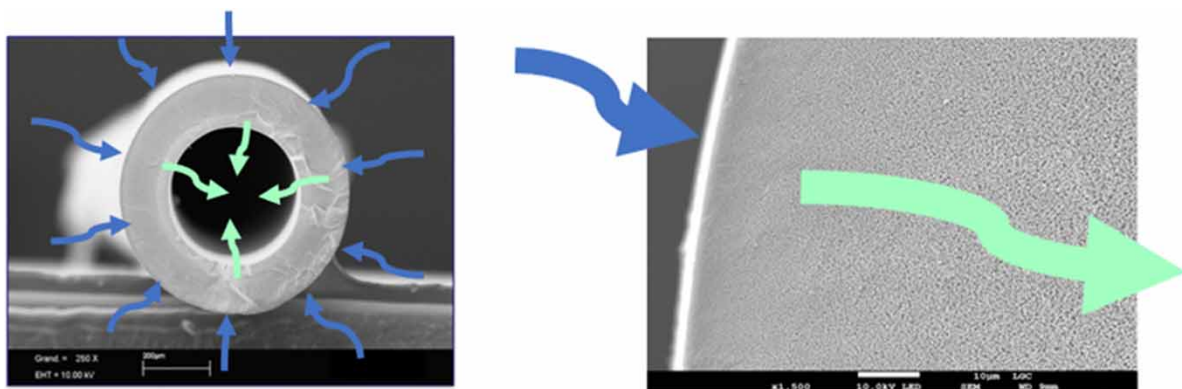
**Figure 4** | Dynamic aging representation.

The minimodules permeate was drained out and not returned to the entrance of the minimodules to ensure the compounds released into the aging solution did not return inside the membrane. The duration of the experiment was several hundreds of hours, allowing a chlorine exposition of at least 100,000 ppmh. The chlorine solution concentration and the pH were checked every 24 hours and adjusted respectively to 1,000 ppm and 6.5 if necessary. At the end of the experiments the minimodules were rinsed and their integrity checked.

## RESULTS AND DISCUSSION

### Fouling tests

The membrane fouling tests were carried out with a natural water taken from the Garonne River in Toulouse, South West of France. On the same bench test (Figure 3) the modules were fed in parallel at a constant flux of 80 L/h.m<sup>2</sup> with backwashes every 60 minutes. UF tap water was used to backwash the membrane at 1.5 bar, which corresponds to a low recovery of 50% but permits consideration that only the irreversible fouling remains in the membrane. Figure 5 shows the permeability ( $L_p$ ) decrease normalised by its initial permeability ( $L_{p_{init}}$ ) over the filtered volume in L/m<sup>2</sup> for the two PVDF membranes M1 and M2 made respectively with and without BCP and for the commercial membrane M3.

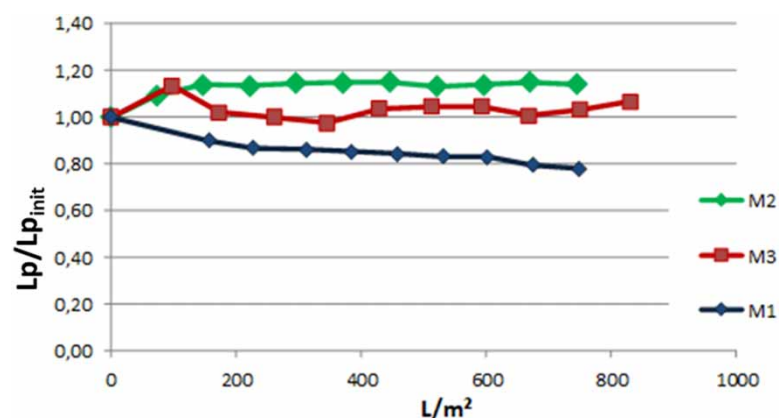

**Figure 5** | Fouling behaviour for the three newly manufactured membranes.

Figure 6 shows the same trials but made with the three aged membranes after 100,000 ppmh. The membrane made with BCP kept the same fouling behaviour even after a long ageing time in chlorine when to the contrary the other tested membranes lost their filtration performances quickly.

### ATR-FTIR outer surface characterization of the M2 Neophil<sup>®</sup>

The outer skin composition evolution through the chlorine ageing time was evaluated by ATR-FTIR on a FTIR Nexus apparatus. The spectra of the compounds PVP, BCP and PVDF are sufficiently different to be discriminated. Figure 7 presents the evolution of PVP and BCP concentration normalized by the total mass of the dry membrane (dry matter) for the M2 Neophil<sup>®</sup> membrane.

As expected, the BCP concentration decreases very slowly even after 100,000 ppmh of ageing while the PVP concentration decreases rapidly during the same period.

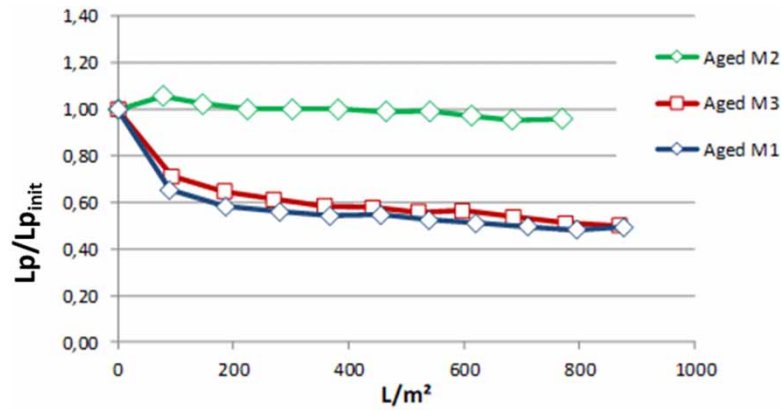

**Figure 6** | Fouling behaviour for the three aged membranes.

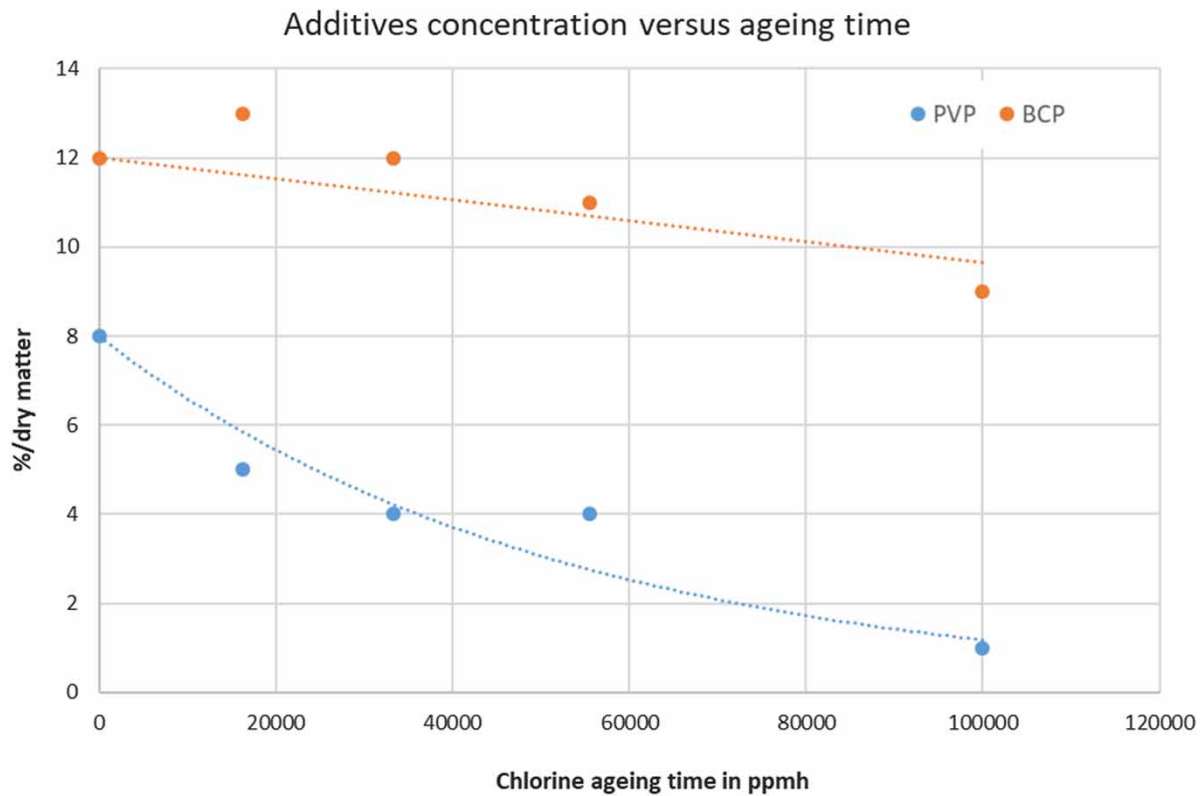
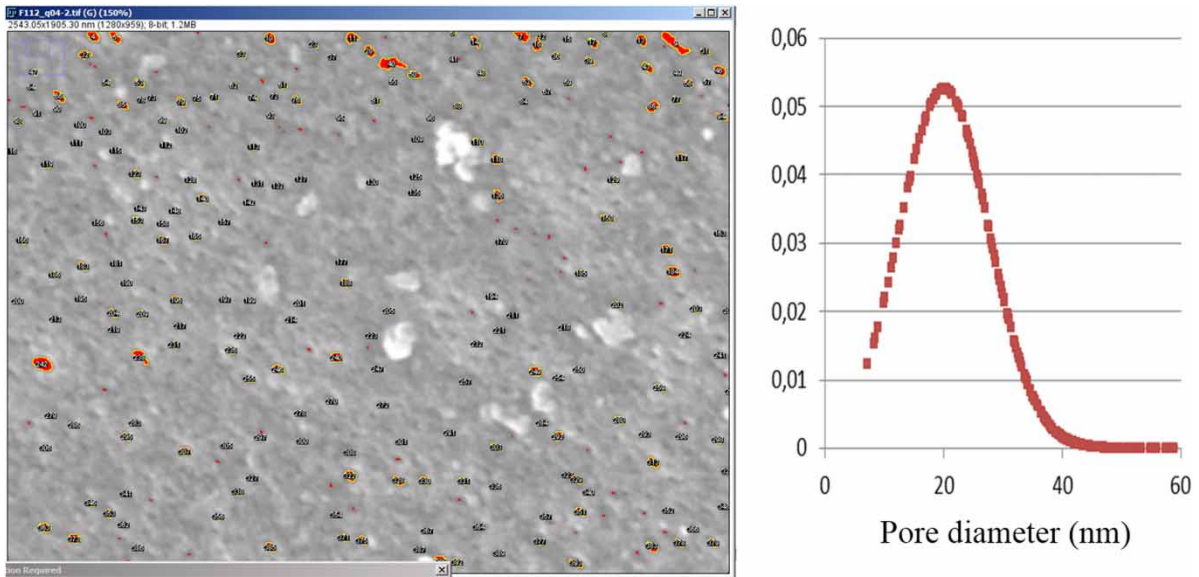

**Figure 7** | Additives concentration evolution as a function of ageing time.

### Pore size distribution of Neophil<sup>®</sup>

The pore diameters were determined by image analysis obtained by SEM of the outer skin. In order to avoid pores collapsing, membrane samples have been soaked successively in water, ethanol and hexane before being finally dried at room temperature. The image analysis consists of defining and measuring each pore as shown in Figure 8 below. Four pictures were taken by membrane sample at different surface localizations.

Figure 9 shows that the average pore diameter of the Neophil<sup>®</sup> membrane made with BCP remains constant even after 100,000 ppmh of chlorine exposure.



**Figure 8** | Example of image analysis and its software treatment.

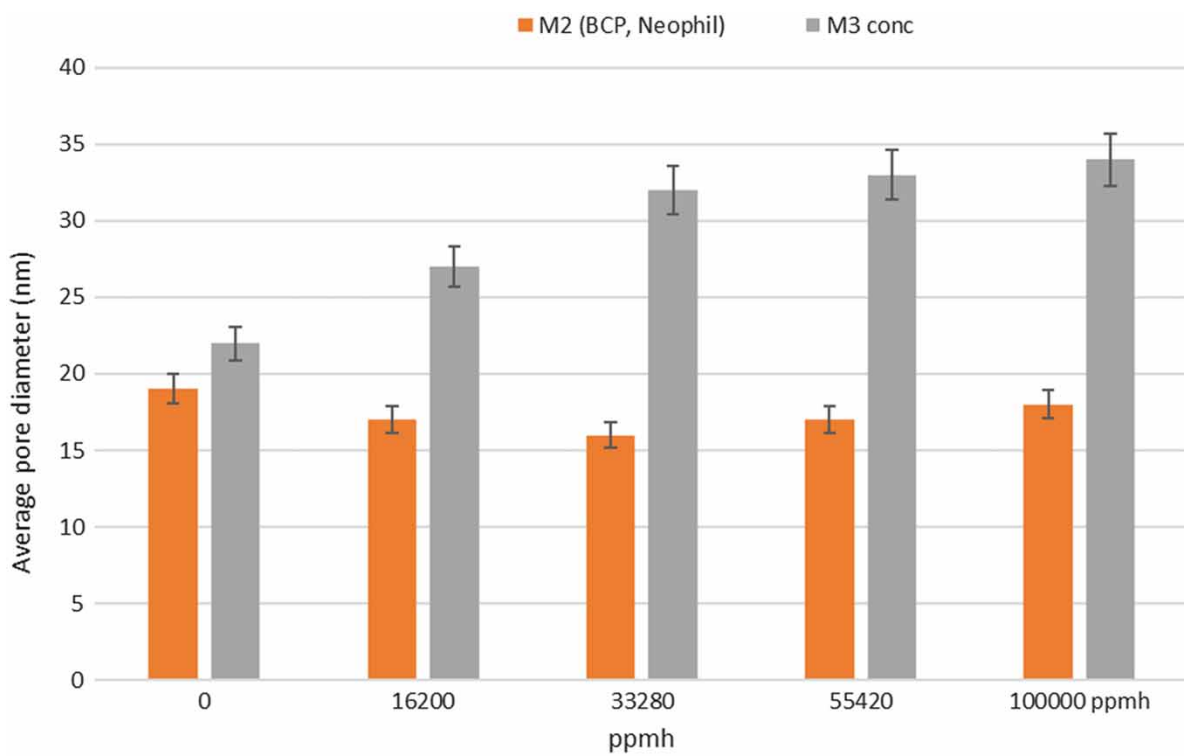

**Figure 9** | Measurement of average pore diameter of Neophil® fiber during chlorine ageing.

### MS2-phage characterization of Neophil®

The trial to assess the capacity of the Neophil® membrane to remove MS2-phages is based on the standard ASTM F838-15A. The MS2-Phages mother solutions were bought at ATCC. The minimodules of 0.3 m<sup>2</sup> were fed by a solution at 10<sup>6</sup> PFU/ml. The MS2-phages concentrations in the inlet and the outlet of the minimodule were determined by counting them in an e-coli lysis plaque assay. [Figure 10](#)

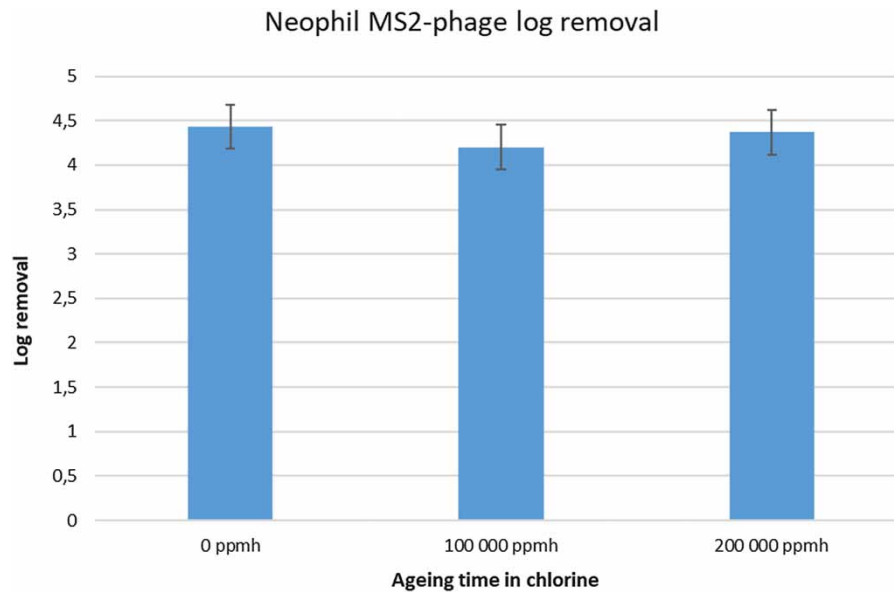

**Figure 10** | M2 Neophil<sup>®</sup> MS2-phage log removal.

shows the results obtained for the Neophil<sup>®</sup> membrane and for the M3 membrane after 100,000 and 200,000 ppmh of chlorine exposure. No log removal decrease was observed for Neophil<sup>®</sup> membrane, confirming that the pore sizes remain similar after long-term ageing.

## DISCUSSION

A new durable hydrophilic PVDF material comprising an amphiphilic di-block copolymer has been successfully used to manufacture a new ultrafiltration membrane, providing significant advantages in the field of water filtration. Compared to conventional additives such as PVP, it has been shown that this type of block copolymer is very resistant to oxidation and is not rinsed out of the membrane during ageing tests. The advantages of this sustainability are demonstrated in fouling tests and rejection tests. In fact, as the hydrophilicity and pore size distribution of the Neophil<sup>®</sup> membrane are not modified during ageing, the performances of the membrane remain constant over time. On the contrary, the conventional market-leading membrane loses its additives during ageing. This phenomenon involves hydrophobisation of the membrane and enlargement of its pores, causing fouling increase and a decrease in the rejection performances.

## CONCLUSIONS

In this paper we have developed a new generation of PVDF membrane using Kynar resin and a new block copolymer as hydrophilic additive. This block copolymer stays durably in the PVDF matrix owing to its PMMA block and is not released or degraded by oxidants like chlorine, which is commonly used as a membrane cleaning agent. Compared to conventional hydrophilic additives like PVP, which are easily released out of the membrane, the block copolymer allows the hydrophilicity of the membrane Neophil<sup>®</sup> and its removal efficiency to be maintained even after intensive accelerated ageing trials of 100,000 ppmh and 200,000 ppmh. Pilot experiments and full plant references equipped with the Neophil<sup>®</sup> membranes are now confirming this strong benefit at larger scales.



---

**ACKNOWLEDGEMENT**

This work was supported by the FUI11-French Government Interministerial Funding Programme.

---

**REFERENCES**

- Causserand, C., Pelligrin, B. & Rouch, J. C. 2015 Effects of sodium hypochlorite exposure mode on PES/PVP ultrafiltration membrane degradation. *Water Research* **85**, 316–326.
- Kosar, W., Lorain, O., Marcellino, S., Beaume, F. & Pierre, G. 2017 Amphiphilic diblock copolymer and use of same for producing polymeric filter membranes. Patent no. WO2017134067.
- Liu, Y., Su, Y., Li, Y., Zhao, X. & Jiang, Z. 2015 Improved antifouling property of PVDF membranes by incorporating an amphiphilic block-like copolymer for oil/water emulsion separation. *RSC Advances* **5**(27), 21349–21359.
- Nunes, S. P. 2016 Block copolymer membranes for aqueous solution applications. *Macromolecules* **49**(8), 2905–2916.
- Oikonomou, E., Karpati, S., Gassara, S., Deratani, A., Beaume, F., Lorain, O., Tencé-Girault, S. & Norvez, S. 2017 Localization of antifouling surface additives in the pore structure of hollow fiber PVDF membranes. *Journal of Membrane Science* **538**, 77–85.
- Pearce, G. K. 2011 *UF/MF Membrane Water Treatment: Principles and Design*. Water treatment Academy, Bangkok, Thailand.
- Ravereau, J., Fabre, A., Brehant, A., Bonnard, R., Sollogoub, C. & Verdu, J. 2016 Ageing of polyvinylidene fluoride hollow fiber membranes in sodium hypochlorite solutions. *Journal of Membrane Science* **505**, 174–184.